



# Solar PV Module Handling, Storage, Installation, Operation & Maintenance



ISSUE DATE: NOVEMBER 2024

REN/WI-ENGG HSIOMPVM/169



**RENEWSYS CONFIDENTIAL:**

This document is the property of RenewSys and contains information which is confidential and proprietary to RenewSys. This document must not be copied, reproduced or disclosed to third parties without the written consent of RenewSys.

## Contents:

01. Introduction .....	1
02. Disclaimer of liability .....	1
03. General information & safety .....	1
04. Unloading, unpacking & storage .....	4
04.1. Unloading .....	4
04.1.1. Attention in loading and unloading with hoisting .....	4
04.2. Unpacking & storage .....	6
04.3 Module representation .....	8
05. Installation.....	9
06. Operating conditions.....	10
06.1. Application class & safety class.....	11
07. Applicable solar module models .....	12
08. Module mounting .....	12
09. Solar module grounding .....	15
10. Solar module wiring .....	16
11. Diodes .....	18
11.1. Bypass diodes .....	18
11.2. Blocking diodes .....	19
12. Note on serial number nomenclature .....	19
13. Maintenance & Product Life Cycle .....	20
13.1. Cleaning instructions.....	20
14. Disclosures for field failures of solar PV modules.....	22
15. Warning .....	22
16. Solar module packing at RenewSys India Pvt. Ltd .....	22
16.1. General .....	22
16.2. Flow chart of standard box packing - 1&2 .....	24
16.3. Flow chart of standard box packing - 3 .....	26
16.4. Special box packing .....	27
17. Disposal.....	27
18. Contact & Communication.....	28

## **01. INTRODUCTION**

Thank you for choosing RenewSys Solar PV modules. This manual contains information regarding handling, storage, installation, operation, maintenance and safety handling of RenewSys's photovoltaic modules.

Before installation or using the RenewSys PV modules, it is must and important to read this manual and understand the instructions carefully.

## **02. DISCLAIMER OF LIABILITY:**

Since On-Site compliance to the recommendations contained in this Handling, Storage, Installation, Operation and Maintenance Manual, and the conditions of installation, operation, use and maintenance of the module are beyond RenewSys's control; RenewSys does not assume responsibility and expressly disclaims liability for loss, damage, injury or expense arising out of or in any way connected with such installation, operation, use or maintenance of the module.

RenewSys assumes no responsibility for any infringement of patents or other rights of third parties that may result from use of the module. No license is granted by implication or otherwise under any patent or patent rights.

The information in this Manual is based on RenewSys's knowledge and experience and is believed to be reliable; but such information including product specifications (without limitations) and suggestions do not constitute a warranty, expressed or implied. RenewSys reserves the right to make changes to the product, specifications or this manual without prior notice.

## **03. GENERAL INFORMATION & SAFETY:**

PV modules generate electricity upon direct exposure to light, which can produce electrical shock. Use of insulated tools and gloves is recommended while working with modules in sunlight. No metallic contacts should be on the human body.



The installation of solar PV modules should only be performed by a qualified licensed professional, including, without limitation, licensed contractors and licensed electricians. The installer assumes the risk of all injury that might occur during installation, including without limitation, the risk of electric shock.



All PV systems must be earthed as per local regulations, if not otherwise specified it is recommended that requirements of the latest National Electrical Code, ANSI/NFPA 70 (2014- 2017) or other national or international electrical standards be used.

- Cover the entire front surface of the PV modules with a dense, opaque & dry material, during installation and handling of the modules.
- Do not keep the unpacked modules one on top of the other, such that the glasses of modules facing each other.
- Avoid water / wet objects contact with glass surface of the module.
- Do not damage or scratch the back sheet.
- Do not expose Back sheet foil directly to sunlight.
- Do not clean the glass with chemicals.
- Work only under dry conditions, with dry modules and tools. Be sure to completely ground all modules.
- Since sparks may occur, do not install the module where flammable gases/materials or vapours are present.
- Do not stack on more than one pallet. Maximum height is two pallets. Severe stacking can cause stress to the module and may cause product damage.
- Use module for its intended function only.
- Be sure that all other system components are compatible, and they do not subject the module to mechanical or electrical hazards.
- Do not use the junction box to hold or transport the module. Do not drop module or allow objects to fall on module.
- Do not stand or step on the module during the cycle time of the module.



**DO NOT STEP ON**

- Do not disassemble, modify or adapt the module or remove any part or labelling installed by the manufacturer.
- Do not drill holes in the frame or glass of the module.
- Do not treat back sheet and front surface of the module with paint and adhesives. Do not artificially concentrate light on the module.



- Do not change the wiring of bypass diodes.
- Do not disconnect modules under load.
- Always transport and store the module in the shipping container provided.
- When carrying a module two or more people should carry it by its frame and wear non-slip gloves (to avoid injury by a slipping module, to a foot, or cuts by the edge of a frame, and so on).
- Do not leave the module unsupported or unsecured prior to installation. For example, wind can cause a module which is leaning against a fence to fall and break. Avoid application of excessive bending or twisting forces to the module.
- If at all any damaged modules are received, Customers are requested to intimate RenewSys (along with support photographs of damaged pallets-on vehicle) for Insurance claim purpose on same day of receipt of container.
- A module with broken glass or torn Backsheet cannot be repaired and must not be used since contact with any module surface or the frame can produce electrical shock.
- Broken or damaged modules must be handled carefully and disposed of properly. Broken glass can be sharp and can cause injury if not handled with the appropriate protective equipment.
- Construction or structure (roof, facade, etc.) where the modules are being installed should have enough strength. Both roof construction and module installation design have an effect on the fire resistance of a building. Improper installation may contribute to fire hazards.
- Do not use modules of different specifications in the same system.
- Use only stranded or solid copper single –conductor type UF or USE cable rated sunlight resistant, for modules and modules interconnect wiring that is exposed to weather.
- Grounding of the module frame is required. Where ground wires greater than 6mm<sup>2</sup> (No.10 AWG) are required, the installer will need to provide suitable terminal connectors.
- Conductor recommendations: single conductor cable, type USE-2 12 AWG, rated 1000 V / 1500 V minimum, 90°C minimum, marked sunlight resistant.
- RenewSys PV Modules have a Class C fire resistance rating in accordance with IEC 61730 certification, the fire rating of this module is valid only when mounted in the manner specified in the Module mounting instructions” Roof constructions and installations may affect the fire safety of a building; improper installation may create hazards in the event of a fire.
- In the case of a fire, SPV modules may produce dangerous voltage/surge current, even if they have been disconnected from the inverter, or have been partly or entirely destroyed, or the naked wiring destroyed.
- Meaning of crossed–out wheeled dustbin: Do not dispose of electrical appliances as unsorted municipal waste, use separate collection facilities. Please refer point no 17 for information regarding the collection systems available. If electrical appliances are disposed of inland fills or dumps, hazardous substances can leak into the groundwater

and get into the food chain, damaging your health and well-being. When replacing old appliances with new ones, the retailer is legally obligated to take back your old appliance for disposals at least free of charge.



## 04. UNLOADING, UNPACKING AND STORAGE

### 04.1. UNLOADING:

- At receipt of PV modules, verify the product details as it had been ordered. Packing list pasted outside the box contains all details including the serial number of modules.
- It is recommended to unload the packing box by using forklift only.
- Always move full bulk pack solution via forklift or jack entering from the short side. In the process of loading and unloading, the forklift should be selected according to the size and weight of the goods. If the fork length is less than 3/4 of the size of the goods, extension sleeves should be fitted on the forks before the assembly is forked, in order to avoid the packing container dumping when moving the forklift.
- When the forklift is loaded with modules, the spacing between the two forks should be adjusted as required to ensure the load of the two forks is balanced without deflection. One side of the assembly box should be close to the retainer.



**Fig: Packing Box – Forklift Handling Images**

- Avoid sharp objects (such as forklift pallet fork) contact or collision with module box body parts, so as not to damage the internal modules.

#### 0.4.1.1. Attention in Loading and unloading with hoisting:

- The hoisting rope of crane unloading needs to choose a longer nylon sling - wire rope is not allowed.
- Before lifting, the length of the sling should be evenly distributed on both sides to avoid the case body tilting to one side during lifting, which causes the sling to be too tight and the assembly to explode.
- When lifting, the box should be kept balanced to avoid tilting.
- In order to minimize the impact of sling on the safety of goods in the process of hoisting, the box should be supported during loading and unloading. **For example**, wooden plank, boards or other fixtures of the same width as the outer packing cases should be used on the upper part of the box to reduce the pressure of the contact position on the box.



**Fig: Packing Box - Adjusting Sling rope for Hoist Handling  
(Separator – Wooden Plank)**

- If, the proposed wooden plank / boards or other fixtures of the same width as the outer packing cases is not available, RenewSys recommends to use the spare/support pallet which is supplied with the consignment as shown in below

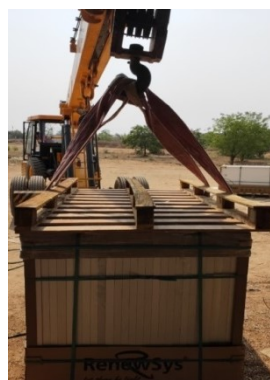



**Fig: Packing Box –Adjusting Sling rope for Hoist Handling (Separator – Pallet)**

- Once unloaded from the container the packing box should always be kept on a flat and even surface.
- The modules should be placed neatly with a safe distance between the boxes. The spacing between boxes should be greater than 30cm.
- Do not stack packing boxes / pallets more than 2 boxes high. If pallets are stored temporarily outside, then the external protective cover to be placed.

**04.2. UNPACKING & STORAGE:**

- Unpacking of PV modules should always be done in the vertical manner by two persons as shown in the diagram. Also care should be taken for falling over one module to the other inside the packing box.
- Modules should be stored in a dry and ventilated environment to avoid direct sunlight and moisture.

**04.2.1 Standard Packing box – 1:**

- Remove the plastic strip using the correct cutting device and Lift the box lid-making sure the inside strip is not cut.
- Cut the inner straps and push the modules towards a well build wall or pole for supporting the modules, so that don't fall towards the unloading side.



**Fig: Cutting of the packing strip      Fig: Opening the lid of Standard Packing box - 1**

**04.2.2 Standard Packing box – 2:**

- Remove plastic strip using the correct cutting device and Lift the box lid

- Remove the inner plastic strip; making sure the inside strip is not.
- Cut the inner straps and push the modules towards a well build wall or pole for supporting the modules, so that don't fall towards the unloading side.



**Fig: Opening the lid of Standard Packing box - 2**

#### 04.2.3 Standard Packing box – 3:

- Remove the outside plastic strip using the correct cutting device and Lift the box lid, make sure the inside strip also removed carefully without touching modules.
- Cut the inner straps and push the modules towards a well build wall or pole for supporting the modules, so that don't fall towards the unloading side.



**Fig: Opening the lid of Standard Packing box - 3**

#### 04.2.4 Special Packing box:

- Remove plastic strip using the correct cutting device and Lift the box lid.
- Place the module in a safe place to avoid damage.
- PV module surfaces may get damaged/scratched if not handled carefully. No paint or adhesive to be applied to any of the surfaces including frame.

- Do NOT connect male & female connectors of the Junction box cable of the module.

















**Fig: Opening the lid of Special packing box**

- Do NOT use a knife to cut the zip-ties, but use wire cutting pliers.
- Do NOT place module directly on top of each other.
- Never lift the modules by the Connecting leads or the Junction Box.
- Pallets should be handled using forklift trucks.
- For safety reasons pallets should not be piled more than specified layers as shown on the outer carton box tube , and they should only be moved using the correct mechanical equipment.
- Pallets should be placed one on top of the other so that corners are flush and there is no overhang.



### UNPACKING & STORAGE INSTRUCTIONS

<p><b>PRECAUTIONS:</b></p> <ul style="list-style-type: none"> <li> Pallet placement - only on a flat surface</li> <li> Do not use a knife</li> <li> Do not transfer the modules horizontally</li> </ul>	<p><b>TOOLS &amp; EQUIPMENT:</b></p> <ul style="list-style-type: none"> <li> Forklift</li> <li> Hydra with top separators</li> <li> Safety gloves</li> </ul>	<p><b>UNPACKING:</b></p> <ul style="list-style-type: none"> <li> Inspect the box</li> <li> Cut the outer straps</li> <li> Remove the lid cover</li> <li> Support the modules in box on a wall or a strong pole</li> <li> Remove one module at a time</li> </ul>	<p><b>STORAGE:</b></p> <ul style="list-style-type: none"> <li> Bottom-most module to be placed with the glass facing upwards</li> <li> Do not stack more than 20 modules</li> <li> Place a cardboard between each of the modules</li> <li> Store in a safe place</li> </ul>
--	---	--	---

While we take the utmost care to ensure the safe delivery of our products, if there is any damage found on receipt, kindly mention the same on the 'Proof of Delivery'. Any damages not mentioned in the POD should be conveyed to the RenewSys representative within 5 working days of off loading the material with the supporting evidence.

### 04.3 MODULE REPRESENTATION:



Each module has a unique serial number, which is laminated behind the glass. Please record the serial numbers during an installation for your future records. A nameplate containing model name, electrical and safety characteristics of the module is also affixed to the back side.

## **05. INSTALLATION:**

This section contains electrical and mechanical specifications needed before using your PV modules.

- Modules should be firmly fixed in place in a manner suitable to withstand all expected loads, including wind and snow loads. Module mounting holes are provided for easy installation and proper mechanical loading.
- Appropriate material should be used for mounting hardware to prevent the module frame, mounting structure, and hardware itself from corrosion.
- To maximize the annual yield, please calculate the optimum orientation and tilt for PV modules in that specific installation site. The highest yields are achieved when sunlight shines perpendicularly onto the PV modules.
- Install modules where they are not shaded by obstacles like buildings and trees. Especially pay attention to avoid partially shading the modules by objects during the daytime.
- Even minor partial shading (e.g. dirt deposits) reduces yields. A module can be considered to be unshaded if its entire surface is free from shading all year round. Sunlight should be able to reach at least the module even on the shortest day of the year.
- Constant shading conditions can affect module service lifetime, due to accelerated ageing of the encapsulation material and thermal stress on the bypass diodes.
- According to UL 1703, any other specific clearance required for maintaining a system fire rating should prevail. Detailed clearance requirements pertaining to system fire ratings must be provided by your racking supplier.
- Minimum distance between each Solar PV Module should be 7.0 mm.
- PV modules are not to be subjected to wind or snow loads exceeding the maximum permissible loads and should not be subjected to excessive forces due to the thermal expansion of support structures; careful consideration has to be shown during system design and installation.
- Clearance between the module frame and the mounting surface 4 inches is required to allow cooling air to circulate around the back of the module. This also allows any

condensation or moisture to dissipate. The module should never be sealed to the mounting surface with sealant that prevents air from circulating under the module.

- Insert interconnect connectors fully and correctly. Check all connections. The interconnect cable should be securely fastened to the module frame, Cable support should be done in a way to avoid the connector from scratching or impacting the back sheet of the module.
- The connectors should be rigidly fastened to the module or any rigid structure to ensure that the wires are not hanging or that the connectors are not exposed to any direct flow of water and debris.
- It is a must to remove the transparent plastic film coming along with the frame before Installation of modules.

#### **05.1. For Bifacial Modules (DESERV EXTREME-XXX models):**

In addition to the above points, the below points are also to be taken care

- For optimizing the power generation of the rear side of bifacial modules, obstacles between modules and the mounting ground should be avoided.
- Bifacial modules use direct, reflected, or diffuse sunlight on the backside to generate additional power. Therefore, bifacial modules are not suggested to be used in building attached photovoltaic systems (BAPV). If BAPV, or similar mounting is still required, sufficient clearance of at least 10 cm (3.94 in) between the module and the mounting surface needs to be provided to allow cooling air to circulate around the back of the module. This also allows condensation or moisture to dissipate.
- Bifacial module cables should always be fastened on module frames or mounting rails, in order to avoid shading on module rear side.

#### **06. OPERATING CONDITIONS:**

Modules should be operated under Standard Operating Conditions (SOC). An installation location with conditions exceeding SOC or with other Special Conditions, below should be avoided. SOC of these modules is as follows:

- The modules should be operated only in terrestrial applications. No space or other Special Conditions.

- When modules have been pre-installed, but the system has not been connected to the grid yet, each module string should be kept under open-circuit conditions and proper actions should be taken to avoid dust and moisture penetration inside the connectors.
- Do not connect different connectors (brand and model) together.
- Please refer the respective technical datasheet of the solar module for the operating conditions related to ambient temperature & relative humidity.
- Make sure that all connections are safe and properly mated. The PV connector should not be subject to stress from the exterior. Connectors should only be used to connect the circuit. They should never be used to turn the circuit on and off.
- Connectors are not waterproof when unmated. When installing modules, connector should be connected to each other as soon as possible or appropriate measures (like using connector endcaps) should be taken to avoid moisture and dust penetrating into the connector.
- Do not clean or precondition the connectors using lubricants or any unauthorized chemical substances.
- Secure the cables to the mounting system using UV-resistant cable ties. Protect exposed cables from damage by taking appropriate precautions (e.g. placing them inside a metallic raceway like EMT conduit). Avoid exposure to direct sunlight.
- Protect exposed connectors from weathering damage by taking appropriate precautions. Avoid exposure to direct sunlight.
- Do not place connectors in locations where water could easily accumulate.
- Do not drill any extra ground holes for convenience as this will void the modules warranty.
- Cement, Coal, Ash, Clinker dust contaminants on the surface of solar panels can reduce the efficiency of solar panels and affect their lifespan. Cement dust settling over the solar panels as it forms a permanent layer when it is mixed with rain or water drops, cleaning frequency should be increased in such a way that contaminants must not settled on the module.
- The installation place should be less than 1,000m (3,280ft) above sea level. Above 1,000m are allowed only if the wind pressure load for a module is less than 2,400N/m<sup>2</sup> (50.12lb/ft<sup>2</sup>).

**\* NOTE:**

The mechanical load bearing capacity depends upon the Installer's mounting methods and failure to follow the instructions of this manual may result in different capabilities to withstand snow and wind loads. The system installer should ensure that installation methods used meet these requirements and any local codes and regulations.



### 06.1. Application Class & Safety Class:

RenewSys modules are qualified for application class A: Hazardous voltage (IEC 61730: Higher than 50 VDC; EN 61730: Higher than 120 V), hazardous power applications (Higher than 240 W) where general contact access is anticipated (modules qualified for safety through EN 61730-1 and 61730-2 within this application class are considered to meet the requirement for Safety Class II).

### 07. Applicable Solar Module Models:

DESERV M6 -XXX	DESERV 3M6 -XXX	DESERV 3S6 -XXX
DESERV 3M6H -XXX	DESERV 3S6H -XXX	DESERV C24 -XXX
DESERV SGALACTIC -XXX	DESERV C12 -XXX	DESERV S6 -XXX
DESERV MGALACTIC -XXX	DESERV XPrime -XXX	DESERV C60 -XXX
DESERV EXTREME - XXX	DESERV Prime -XXX	DESERV SGALACTIC 120 -XXX
DESERV SGALACTIC 144-XXX	DESERV SGALACTIC 156 -XXX	DESERV EXTREME 120 -XXX
DESERV EXTREME 144 -XXX	DESERV EXTREME 156 -XXX	

- For Electrical Parameters and other detail notes, please refer respective MODEL TDS.
- Rated electrical characteristics may be observed to vary within 10% of the values measured at Standard Test Conditions (STC) of: 1000 W/m<sup>2</sup>, 25<sup>0</sup>C cell temperature and solar special irradiance per IEC 60904-3.

### 08. MODULE MOUNTING:

The frame of each module has 8 mounting holes (Length\* Width: 12 mm\*8 mm) used to secure the modules to support structure. If the wind or snow loads is less than 2400 Pa, Customer can use the four symmetry holes close to the inner side on module frame, if the wind or snow load is bigger than 2400 Pa, you must use all the eight mounting holes. The module frame must be attached to a mounting rail using M6 corrosion-proof screws together with spring washers and flat washers in eight Symmetrical locations on the PV module. The applied torque should be big enough to fix it steadily.

Clamp fitting is not certified however, if customer wants to use, should have to contact RenewSys for acceptance.

Larger format modules having additional mounting holes, the mounting method and maximum test loads are shown as follow. Please refer to the module datasheet for the number of holes, dimensions and placement.

Model	Four inner mounting holes (max. test load Pa)	Eight mounting holes (max. test load Pa)
DESERV SGALACTIC/EXT/G-G-108X	≤2400 , 901PITCH	>2400, 901PITCH+Outer holes
DESERV SGALACTIC/EXT/G-G-120X	≤2400 , 996PITCH	>2400, 996PITCH+Outer holes
DESERV SGALACTIC/EXT/G-G-144X	≤2400 , 1400PITCH	>2400, 1400PITCH+Outer holes
DESERV SGALACTIC/EXT/G-G-156X	≤2400 , 1285PITCH	>2400, 1285PITCH+Outer holes

Please find detailed mounting information in the below illustration.

The below figure is for hardware mounting reference:

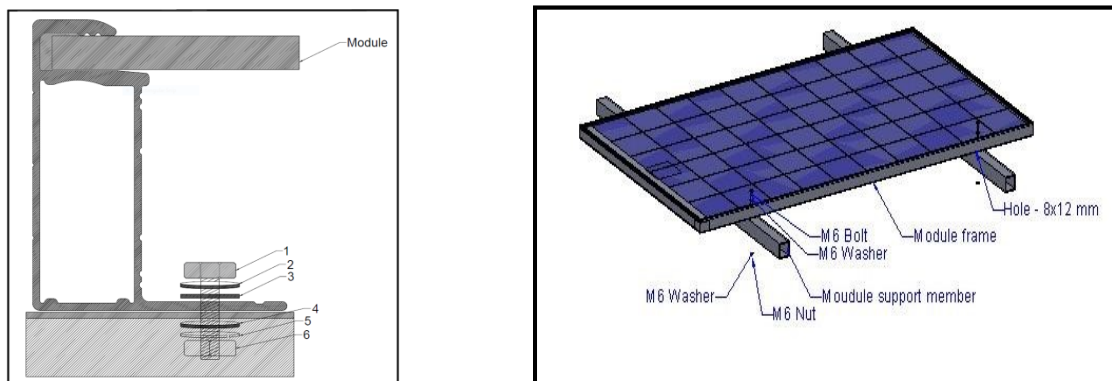

**Fig: Mounting Details-1**

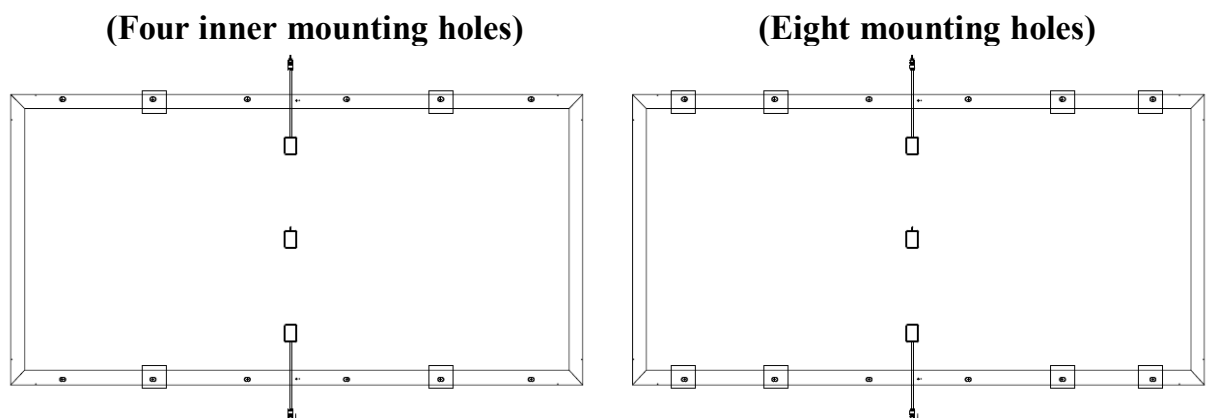



**Fig: Mounting Details-2**

The following hardware recommended should be used for installation of the solar modules.

1. Stainless steel Bolt – 304 with hexagonal head – In Metric standard: M6 x 30 mm long
2. Stainless Steel Flat Washer – M6 Stainless steel 304
3. Stainless Steel Rectangular Washer – 20x40x2mm M6 Stainless steel 304
4. Stainless Steel Flat Washer – M6 Stainless steel 304
5. Stainless Steel Spring Washer – M6 Stainless steel 304
6. Stainless Steel Nut – M6 stainless steel 304
7. Minimum requirement for fixing the module- M6x30 bolts 4nos

Material	Bolt head	Size(MM)	Grade	Torque(NM)	Pitch(MM)	Tensile strength(Mpa)	Yield strength(Mpa)
Stainless steel	Hexagonal	6	304	09-12	1	515	205

Above details are torque chart for tightening the nut and bolt for M6 Nut & Bolt.

**Fig: Mounting Details**

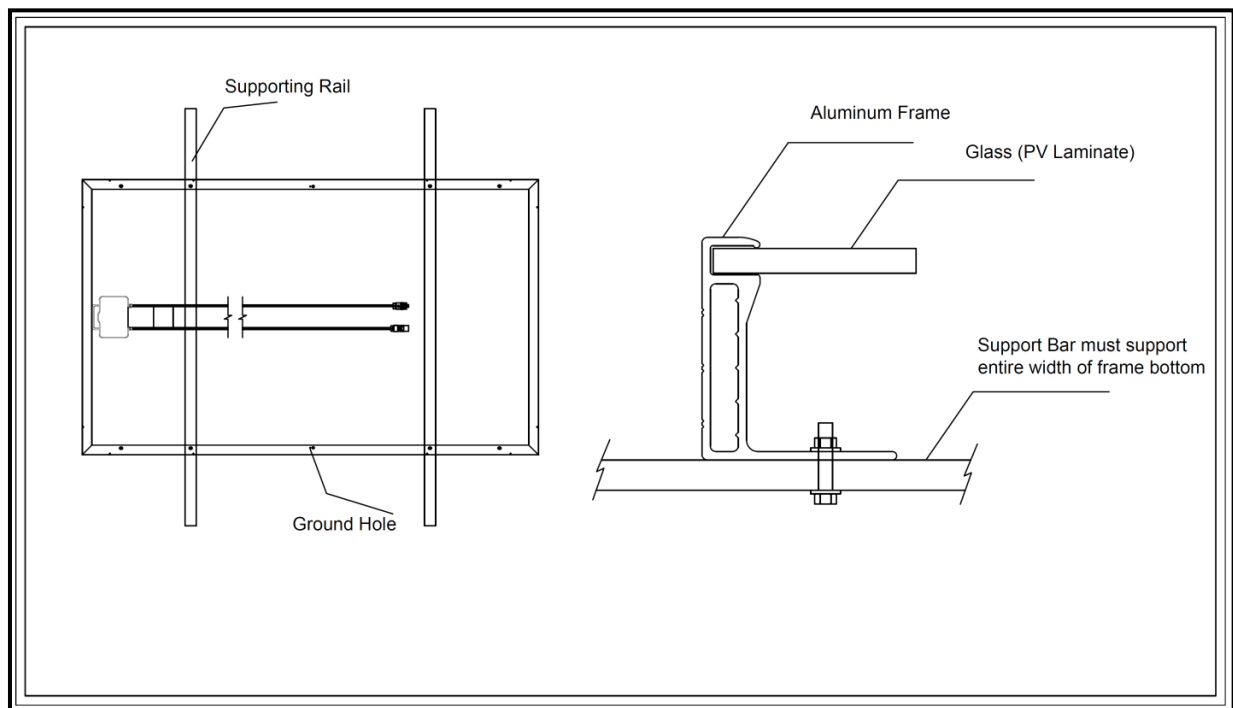

**Fig: Mounting Details-3**

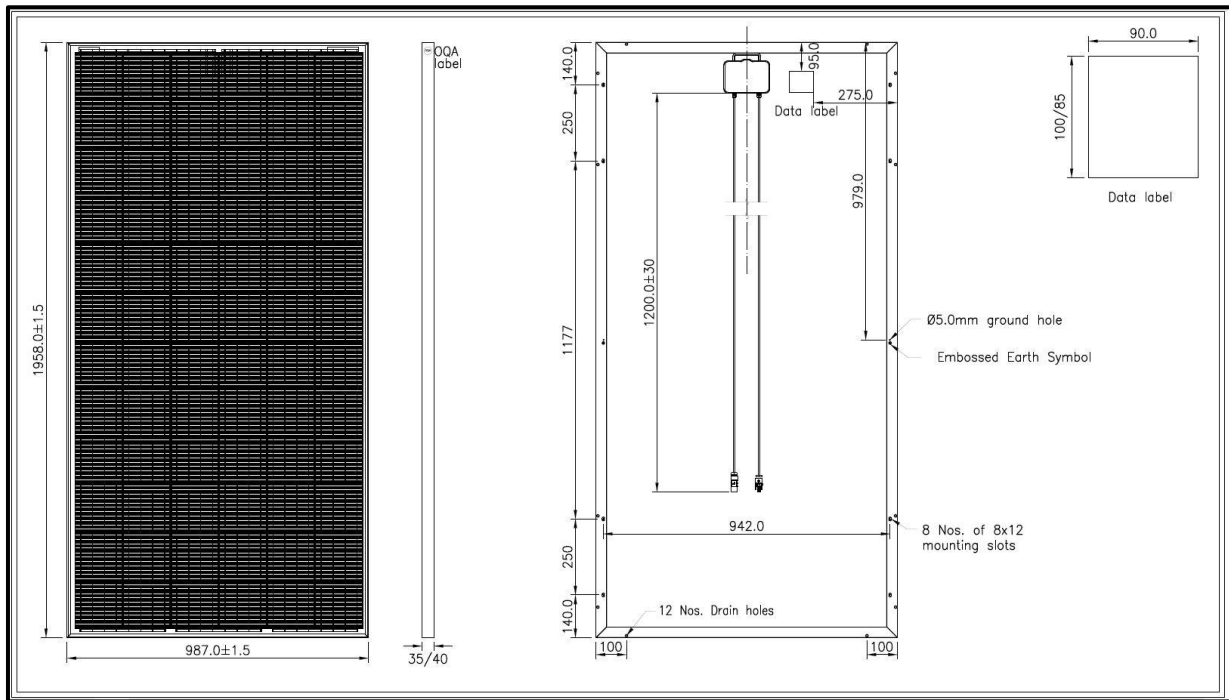

**Fig: Finished Module Details (For Reference only)**

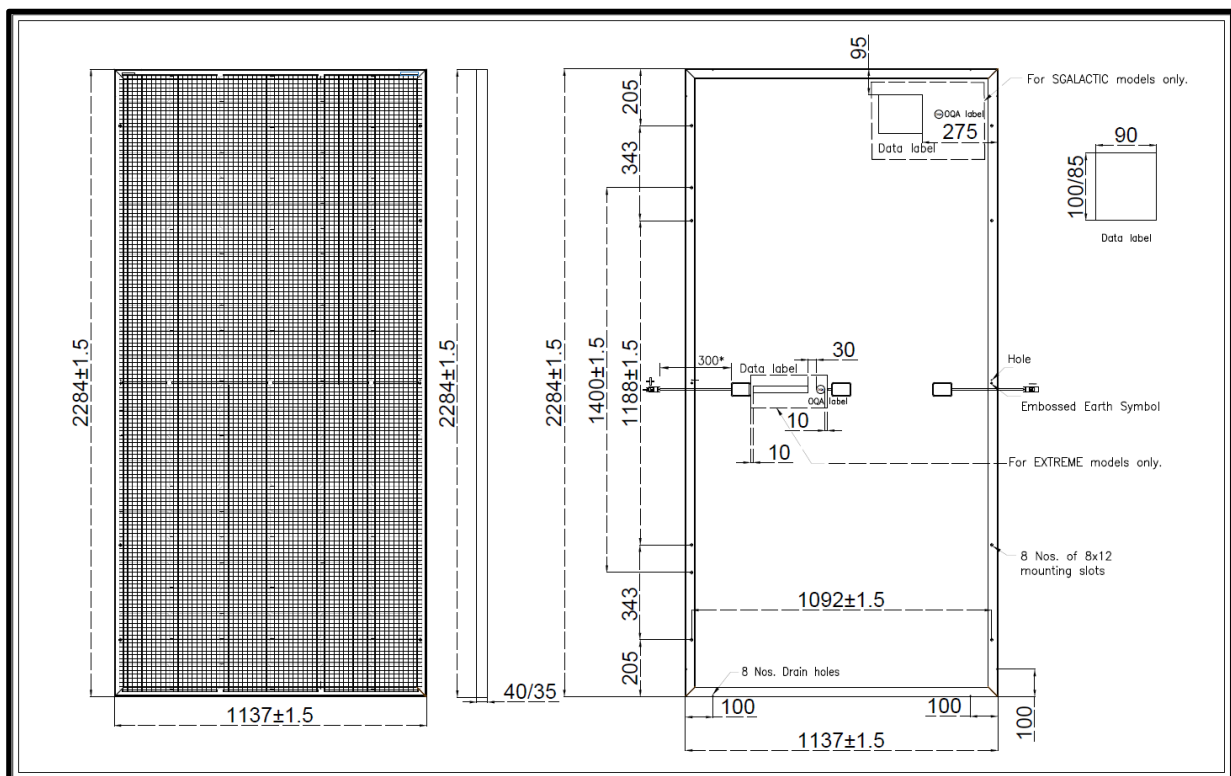

**Fig: Finished Module Details (For Reference only)**

Above mentioned finished module details are for reference purpose only. However please refer technical data sheet of respective model for particular details.

### 09.SOLAR MODULE GROUNDING:

All module mounting frames and mounting racks need to be grounded according to the respective regional electric codes. The module frame must be properly grounded. The grounding wire must be properly fastened to the module frame to ensure good electrical contact. The anodization on a module frame provides a coating to minimize the corrosion due to weather and it acts as a barrier that reduces the effectiveness of the grounding connection. For an adequate ground, the grounding hardware should pierce the anodization layer.

The following hardware recommended should be used for grounding the solar modules during installation process.

- Stainless steel Bolt –304 with hexagonal and cheese head (As per ASME standard chart) In Metric standard: M4 x 16 mm long Engage thread is 13.5 mm with the frame (2.5 mm frame thickness and 16 mm length of the screw)
- Stainless Steel Flat Washer – M4 Stainless steel 304
- Stainless Steel Cupped Washer –M4 Stainless steel 304
- Star Washer – M4 Stainless steel 304
- Stainless Steel Nut – M4 stainless steel 304

Bolt (mm)	Size	Pitch (mm)	Bolt Hex (mm)	Strength Grade (NM)				
				4.6	6.8	8.8	10.9	12.9
4		0.7	7	0.95	1.91	2.54	3.57	4.29

Above details are torque chart for tightening the nut and bolt for M4 & M6 Nut & Bolt

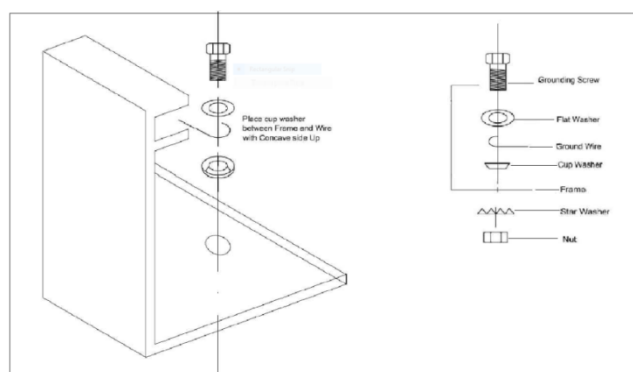

**Fig: Grounding Details**

## 10.SOLAR MODULE WIRING:

- All wiring should be done in accordance with applicable local/ National electrical codes and regulations.
- Before connecting modules always ensure that the contacts are corrosion free, clean and dry Product can be irreparably damaged if an array string is connected in reverse polarity to another.
- Under normal conditions, a photovoltaic module is likely to experience conditions that produce higher current and/or voltage than reported at standard test conditions. Accordingly, the values of Isc and Voc marked on this PV module should be multiplied by a factor of 1.25 when determining component voltage ratings, conductor current ratings, and size of controls (e.g. inverter) connected to the PV output."
- All wiring should be done by a qualified, licensed professional. Wiring should be protected to help ensure personal safety and to prevent its damage.
- Only modules with similar electrical parameters should be connected in the same string to avoid or minimize mismatch effects in arrays.
- Modules can be wired in series to increase voltage. Connect positive terminal of one module to the negative terminal of the next module.

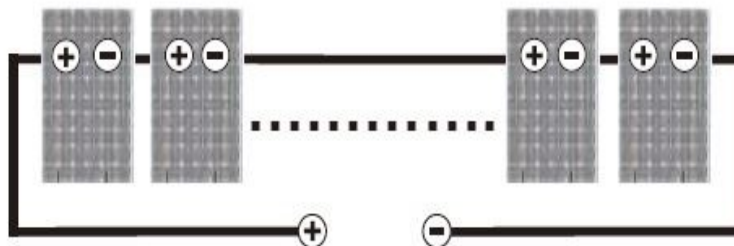

**Fig: Series connection for more Voltage**

- The voltage of the solar PV module changes with the temperature, Considering the voltage increase caused by temperature drop in extreme environment in winter, the maximum series connection number of solar PV modules can be calculated as mentioned in the table below:

Formula*	$X = V / ((1 + \alpha V_{oc} * (T_{min} - T))) * V_{oc}$
<b>X</b>	No of modules in string
<b>V</b>	Max system voltage
<b><math>\alpha V_{oc}</math></b>	Temperature co eff Open circuit voltage
<b><math>T_{min}</math></b>	Minimum temperature in the location
<b>T</b>	STC temperature
<b>Voc</b>	Open circuit voltage

**Table: Maximum series connection number calculation**

\*Note: The final value must be rounded down to the previous digit (Ex. 29.7 must be considered as 29 No's)

- PV modules only with the same rating should be used in series and parallel connections.
- Connect modules in parallel to increase current. Connect wires from the positive terminal of the one module to the positive terminal of the next module. Do not connect modules in parallel without using a connection box. The number of parallel strings depends on the system integrator's requirements and the inverter ratings.

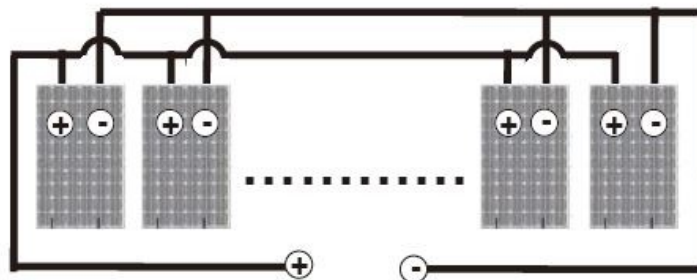

**Fig: Parallel connection for more Current**

- Always verify the voltage and polarity of each individual string before making a parallel connection. If you measure a reversed polarity or a difference of more than 10 V between strings then check the string configuration before making the connection.
- Use system wiring with suitable cross-sectional areas and connectors that are approved for use at the maximum short-circuit current of the module.
- A minimum bending radius of 60 mm (2.36 in) is required when securing the junction box cables to the racking system.



- When reverse currents can exceed the value of the maximum protective fuse marked on the back of the module, a properly rated and certified over current device (fuse or circuit breaker) must be connected in series with each module or string of modules.
- The fuse used is a glass / HRC type of rating 15 Amps. The fuse rating has to be greater than or equal to 135% of the module's short circuit current.
- The rating of the over-current device shall not exceed the value of the maximum protective fuse marked on the back of the module.
- Connecting modules in reverse polarity to a high current source, such as a battery, will destroy the bypass diodes and render the module inoperative. Bypass diodes



are not user replaceable.

- The junction box is under no circumstances being opened. Opening the junction box may void the warranty.
- Ensure the cables & MC4 Connectors are not exposed to water logged areas and must not lay on the Roof/Ground; allowing so can cause material damage or degradation during module life time.

## **11. DIODES:**

### **11.1. Bypass Diodes:**

When the modules are shaded partially, it may cause reverse voltage across cells or modules, because the current from other cells in the same series is forced to flow through the shaded area. This may cause undesirable heating to occur. When a bypass diode is wired in parallel with the series string, the forced current will flow through the diode and bypass the shaded module, thereby minimizing module heating and array current losses. The use of a diode to bypass the shaded area can minimize both heating and array current reduction.

All our modules are equipped with factory installed bypass diodes. The factory installed diodes provide proper circuit protection for the systems within the specified system voltage. If your system specifications require you to add or change diodes, please contact authorized representative for recommendations for the proper diode type.

### **11.2. Blocking Diodes:**

Blocking diodes are typically placed between the battery and the PV module output to prevent battery discharge at night. RenewSys modules do not contain a blocking diode. It is recommended that a charge controller be used to prevent the batteries from being overcharged and discharged at night.



## 12. NOTE ON SERIAL NUMBER NOMENCLATURE:

The serial number nomenclature is provided below:

**R X 0 0 0 W W Y Y X X X X X X**

<b>R</b>	<b>X</b>	<b>0</b>	<b>0</b>	<b>0</b>	<b>0</b>	<b>W</b>	<b>W</b>	<b>Y</b>	<b>Y</b>	<b>X</b>	<b>X</b>	<b>X</b>	<b>X</b>	<b>X</b>	<b>X</b>	<b>X</b>
RenewSys India Pvt. Ltd.	Unit	Reserved for future use				Running week of the year		Year		Running generated by PPC			Sl.	No		

<b>UNIT IDENTIFICATION CODE</b>	
<b>UNIT</b>	<b>Identification no</b>
RenH	1, 2, & 3
RenP	4

## 13. MAINTENANCE & PRODUCT LIFE CYCLE:

- Well-designed PV Plant requires minimum maintenance but however with further maintenance the performance and the reliability of the system can be improved
- Check that the mounting structures are properly laid and the modules are held tightly and are in accordance with the mounting instructions given above
- Ensure all the cable assembly is tight and no part of cable assembly will be exposed to water logging
- Do not open the junction box to change the diodes even if they are defective. Please contact with PV module manufacturer in case of known or suspected diode failure
- Do not make modifications to any component of the PV module (diode, junction box, connectors or others).
- Regular maintenance is required to keep modules clear of snow, bird droppings, seeds, pollen, leaves, branches, dirt spots, and dust.
- Modules with sufficient tilt (at least 15°), generally may not require cleaning (rain will have a self-cleaning effect). If the module has become soiled, wash with water and a non-abrasive cleaning implement (sponge) during the cool part of the day. Do not scrape or rub dry dirt away, as this may cause micro scratches.
- Snow should be removed using a soft brush.
- Periodically inspect the system to check the integrity of all wiring and supports.

- To protect against electric shock or injury, electrical or mechanical inspections and maintenance should be performed by qualified personnel only.
- Product should be recycled in useful renewable method after end of its life cycle

RenewSys is recommending the installers to clean the modules as explained in the below procedure.

### **13.1. CLEANING INSTRUCTIONS:**

- It is recommended to inspect modules for cracks, damage cable joints and loose connections before cleaning of the modules. It is also recommended that personnel shall wear appropriate Personal Protective Equipment (PPE) during cleaning.
- Type of Water: Reverse osmosis (RO) water is an ideal option. If RO is not available, rainwater or tap water can be used. Tap water must be of low mineral content with total hardness less than 75 mg/L. In case mineral content of water used is more than 75 mg/L but less than 200 mg/L, the water must be squeezed off to prevent scale build up over module surface. A long handle commercially available 'squeeze' may be used.
- Do not use abrasive cleaners, de-greasers or any unauthorized chemical substance (e.g. oil, lubricant, pesticide, etc.) on the module.
- Do not use cleaning corrosive solutions containing hydrofluoric acid, alkali, acetone, or industrial alcohol. Only substances explicitly approved by RenewSys India are allowed to be used for cleaning modules.
- Noticeable dirt must be rubbed away by gentle cleaning implement (soft cloth, sponge or brush with soft bristles).
- Cleaning Time: The recommended time for cleaning modules is during low light conditions when production is lowest. The best time to clean modules is from dusk to dawn when the plant is not in operation and risk of electrical shock hazard is minimum.
- Water Pressure: Water pressure should not exceed 35 Bar at the nozzle. Use of high pressure hoses for cleaning may exert excess pressure and damage the modules.
- Water Temperature: Temperature of water used for cleaning should be same as module temperature at the time of cleaning (difference should not be greater than 20°C at maximum. Cleaning should be carried out when the modules are cool to avoid thermal shock which can potentially cause cracks on the modules.
- Removing Stubborn Marks: To remove stubborn dirt such as birds dropping, dead insects, tar etc., use a soft sponge, micro-fibre cloth or a non-conductive non-abrasive brush. It is recommended to soak the dirt point with water/water jet for some time





before using the sponge/brush. Rinse the module subsequently with plenty of water.

- The back surface of the solar module doesn't require any specific cleaning unless any dirt or debris is stuck on the back sheet. While cleaning the dirt on the back sheet avoid any sharp object, which can damage the substrate material and cause a slit.

**Module Safety Instructions:**

- Ensure brushes or agitating tools are not abrasive to glass, EPDM, silicone, aluminium, or steel. Ensure any brushes or agitating tools are constructed with non-conductive materials to minimize risk of electric shock.
- However it is advisable to perform periodic inspection of the modules for damage to glass, Backsheet, frame, junction box or external electrical / loose connections and corrosion by the authorized professional.
- Once a year, or as required as per site conditions, check that growing foliage has not caused module shading. Correct if this condition has occurred.
- As required, check that the system voltage and current output (or power output) is consistent with the expected output. Such a check will help to determine if array cleaning is needed, if there are loose or corroded connections, or if there is a component problem.

**14. DISCLOSURES FOR FIELD FAILURES OF SOLAR PV MODULES:**

In case of any problem/fault/damage identified in solar modules post installation during their life, The customer should report the issue to RenewSys without altering the defected solar modules for providing scope to RenewSys to identify the root cause, if the defected modules removed/tampered/alterd/replaced from mounting structure without RenewSys permission is a warranty void.

**15. WARNING:**

While performing any electrical maintenance, the system must be completely shut down and maintenance should be performed by experts. Failure to comply with norms may result in lethal shocks, burns and sometimes even death.

## 16. SOLAR MODULE PACKING AT RENEWSYS INDIA PVT LTD:

### 16.1. GENERAL:

- Every alternate module is protected by corner protectors as shown below, this helps in protecting the module edges from any scratches on the Al frame.

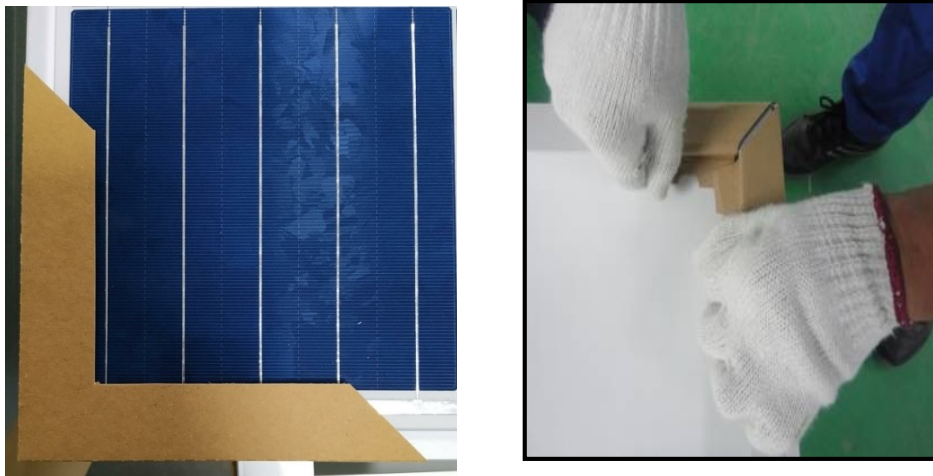

**Fig: Corner Protectors**

- Inside the box each module is placed vertically. Put the module into the carton from one side with protector on four corners. RenewSys recommends that two people should load into and remove the modules from the pack carton for solar PV modules.
- With one hand in the middle of each short side of the frame and the other hand grasping the frame near the corner divider on the top and long side, place the module in the carton standing vertically with the long sides of the frame on the top and bottom.
- Always move full bulk pack solution via forklift or jack entering from the short side.
- The first & last module placed in the carton is placed so that the module glass faces inside of the box. Please do not remove the intermediate-module before removing the last module.

**Warning:** For safety reasons never manipulate or move a partially filled carton, without stabilizing the remaining modules against shifting. Movement may cause the remaining modules to shift within the carton causing an unsafe handling situation, particularly when utilizing a forklift.

- Packing list containing details like Model, WP, Quantity, serial no: with bar code will be pasted on the packing box as in Fig shown below.

<b>X-X-000XXX</b>					
<b>Model No: DESERV- XXX XXX</b>					
Date: XX.XX.20XX			<b>CUD/</b>		
Quantity: XX					
S.No	Serial Number	Barcode	S.No	Serial Number	Barcode
1	R1000001203212064	*P1000001203212064*	14	R1000001203212064	*P1000001203212064*
2	R1000001203212064	*P1000001203212064*	15	R1000001203212064	*P1000001203212064*
3	R1000001203212064	*P1000001203212064*	16	R1000001203212064	*P1000001203212064*
4	R1000001203212064	*P1000001203212064*	17	R1000001203212064	*P1000001203212064*
5	R1000001203212064	*P1000001203212064*	18	R1000001203212064	*P1000001203212064*
6	R1000001203212064	*P1000001203212064*	19	R1000001203212064	*P1000001203212064*
7	R1000001203212064	*P1000001203212064*	20	R1000001203212064	*P1000001203212064*
8	R1000001203212064	*P1000001203212064*	21	R1000001203212064	*P1000001203212064*
9	R1000001203212064	*P1000001203212064*	22	R1000001203212064	*P1000001203212064*
10	R1000001203212064	*P1000001203212064*	23	R1000001203212064	*P1000001203212064*
11	R1000001203212064	*P1000001203212064*	24	R1000001203212064	*P1000001203212064*
12	R1000001203212064	*P1000001203212064*	25	R1000001203212064	*P1000001203212064*
13	R1000001203212064	*P1000001203212064*	26	R1000001203212064	*P1000001203212064*
				<b>XXX Wp</b>	

**16.2. FLOW CHART OF STANDARD BOX PACKING - 1 & 2:**

At RenewSys the standard packing -1 and standard packing -2 of crystalline silicon solar modules consists of a wooden pallet and a packing box as shown in figures below



**Fig: Pallet & Standard Packing Box – 1 & 2**

**Pallet & bottom cover on flat surface**

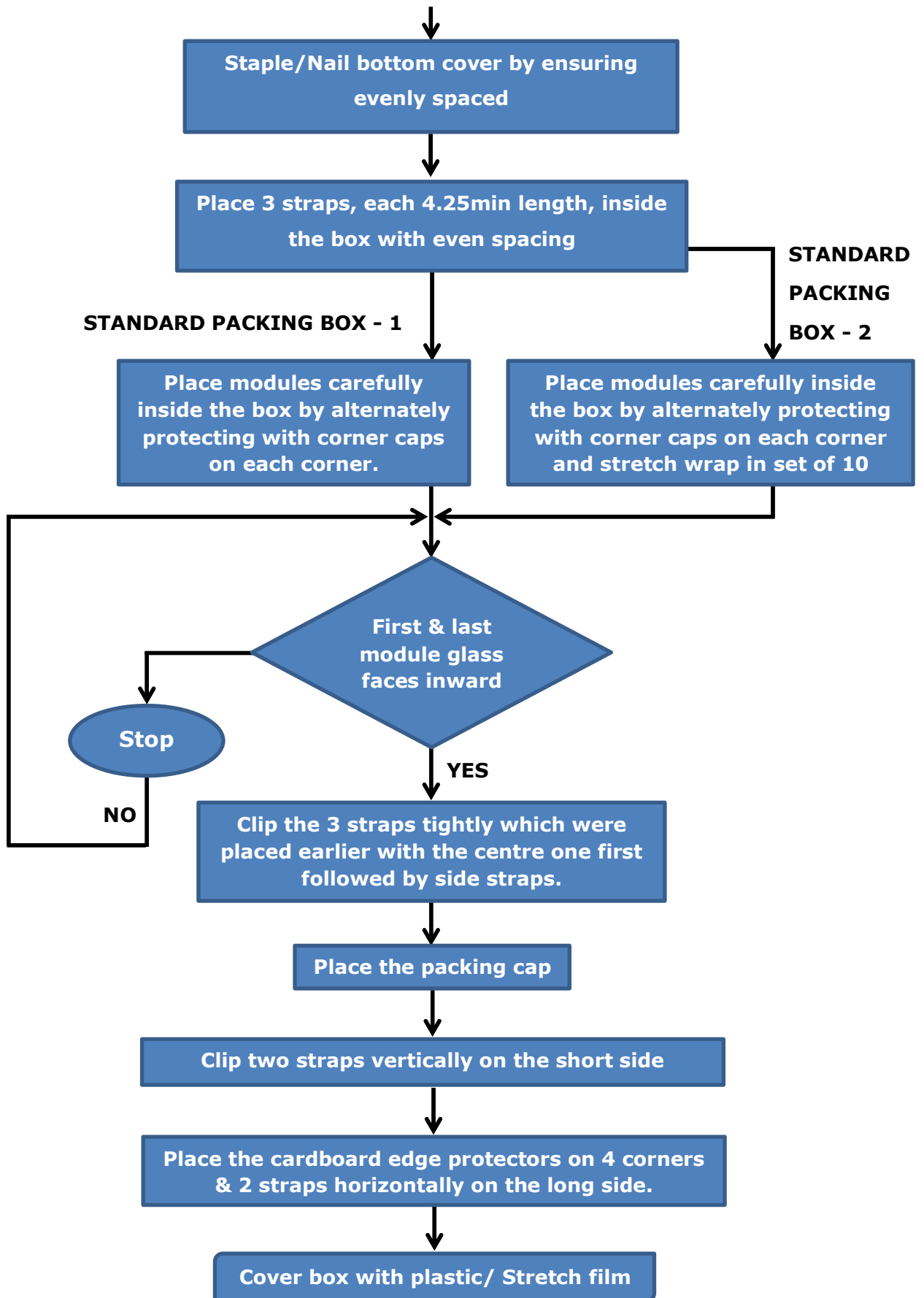

### 16.3. FLOW CHART OF STANDARD BOX PACKING – 3:

At RenewSys the standard packing - 3 of crystalline silicon solar modules consists of a wooden pallet with carton sheet, auto sorter Robo module placing and a packing box as shown in figures below

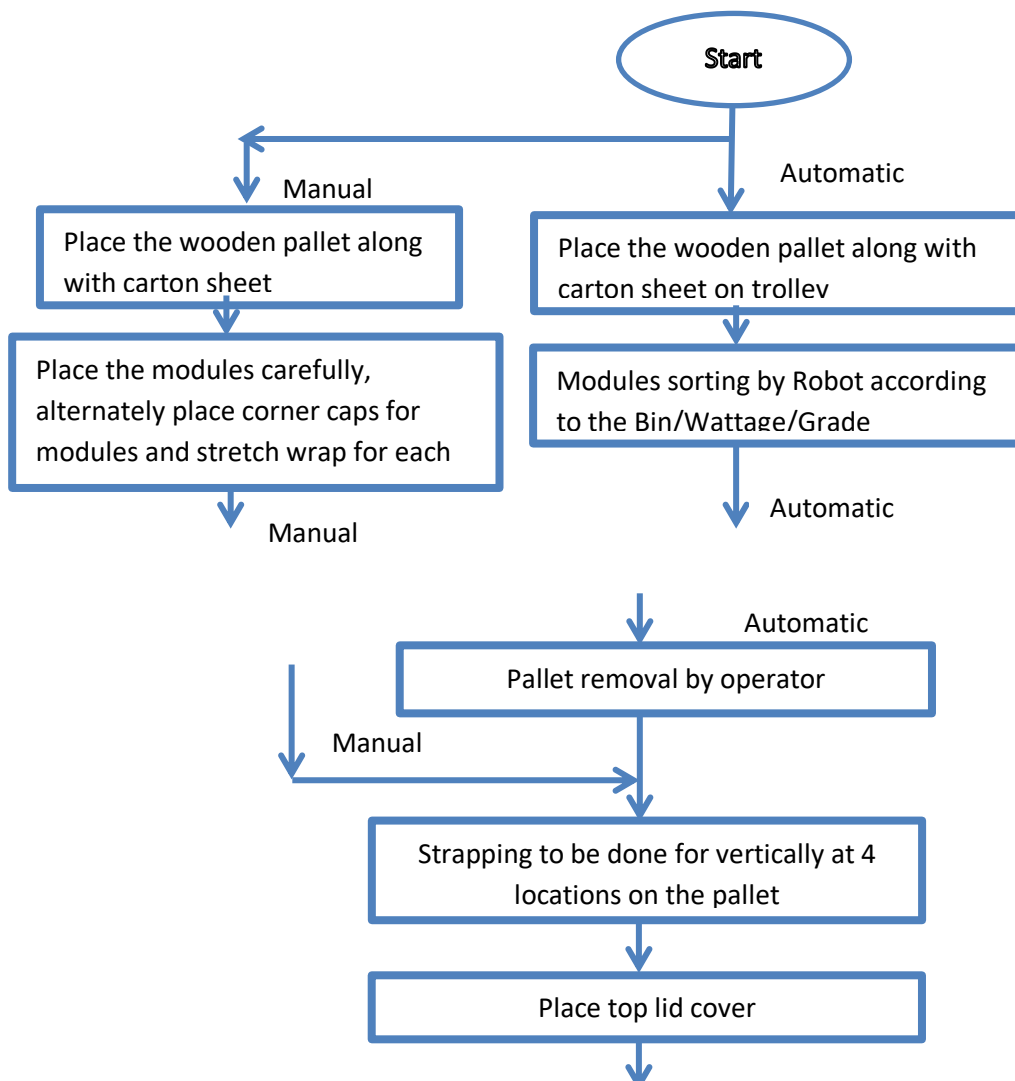

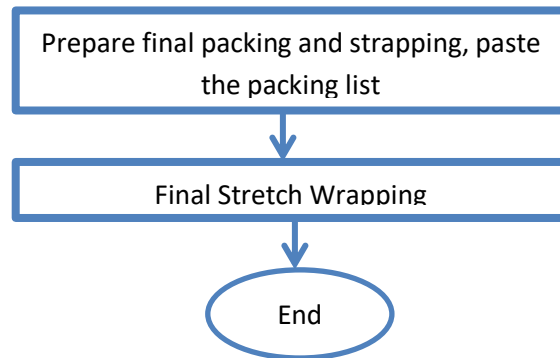

#### 16.4. SPECIAL BOX PACKING:

At RenewSys India Private Limited the standard packing of crystalline silicon solar modules consists of a wooden pallet and a packing box as shown in figures below



**Fig: Pallet & Special Packing Box Images**

#### 17. DISPOSAL

All E-waste disposals must adhere to the appropriate/relevant government notifications and be handed over to an authorized e-waste recycler. [Click here](#) for the list of authorized recyclers.



## **18. CONTACT & COMMUNICATION:**

### **Corporate & Registered Office:**

RenewSys India Private Limited,  
Unit No. 607, 6th Floor, Trade Center,  
Bandra-Kurla Complex, Bandra (East),  
Mumbai, Pin Code: 400 051,  
Maharashtra, INDIA.  
Ph.: +91 22 6810 0500

### **Factory Address - Hyderabad:**

RenewSys India Private Limited,  
Plot No. 6, Survey # 114/P, Srinagar Village,  
Maheshwaram Mandal, Rangareddy Dist. - 501 359,  
Telangana, INDIA.  
Ph.: +91 40 6730 3000

### **Factory Address - Patalganga:**

RenewSys India Private Limited,  
Plot No. E-141, Additional Patalganga MIDC  
Industrial Area, Village - Karade Khurd, Taluka Panvel,  
District Raigad, Pin Code: 410 206  
Maharashtra, INDIA.  
Ph.: +91 21 9268 0100

